

# ST-909R

## SERVICE MANUAL

*E Model*

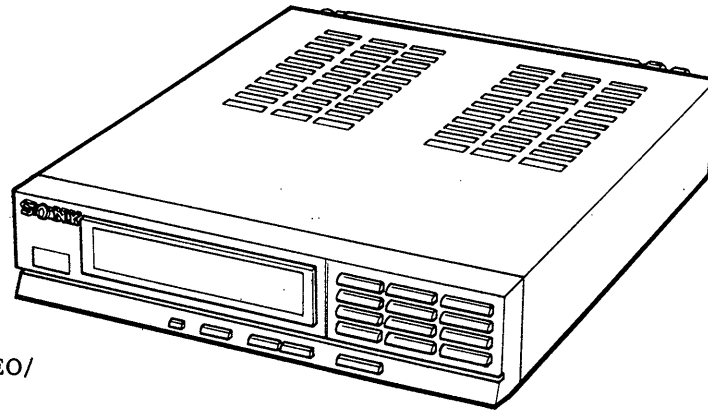

- ST-909R is the FM STEREO/  
FM-AM TUNER in FH-909R.

### SPECIFICATIONS

System FM stereo, FM/AM superheterodyne tuner  
Quartz-locked PLL digital synthesizer system

#### General

Dimensions Approx. 220 × 55 × 240 mm (w/h/d)  
(8<sup>3</sup>/<sub>4</sub> × 2<sup>1</sup>/<sub>4</sub> × 9<sup>1</sup>/<sub>2</sub> inches)  
incl. projecting parts and controls  
Weight Approx. 1.0 kg (2 lb 4 oz) net

#### FM tuner section

Tuning range 87.5 to 108 MHz  
Antenna Telescopic antenna  
Antenna terminals 75 ohms unbalanced  
Intermediate frequency 10.7 MHz  
Usable sensitivity 2.3 μV (S/N = 30 dB/75 ohms)

#### SW/MW tuner section

		SW1	SW2	MW
Tuning range		3.2 - 7.3 MHz	9.5 - 21.75 MHz	531 - 1,602 kHz
Antenna		Telescopic antenna		Built-in ferrite bar antenna
		External antenna terminal		
Usable sensitivity	Built-in ferrite bar antenna	—		250 μV/m (999 or 1,000 kHz)
	External antenna	23 μV (5 MHz)	30 μV (15 MHz)	100 μV (999 or 1,000 kHz)

FM STEREO/FM-AM TUNER  
**SONY**®

## REPAIRING PRECAUTION

### [To apply B+ voltage]

The power of this units is fed from other unit.

When the unit operates individually, connect the regulated power supply to the point as shown in the below figure.

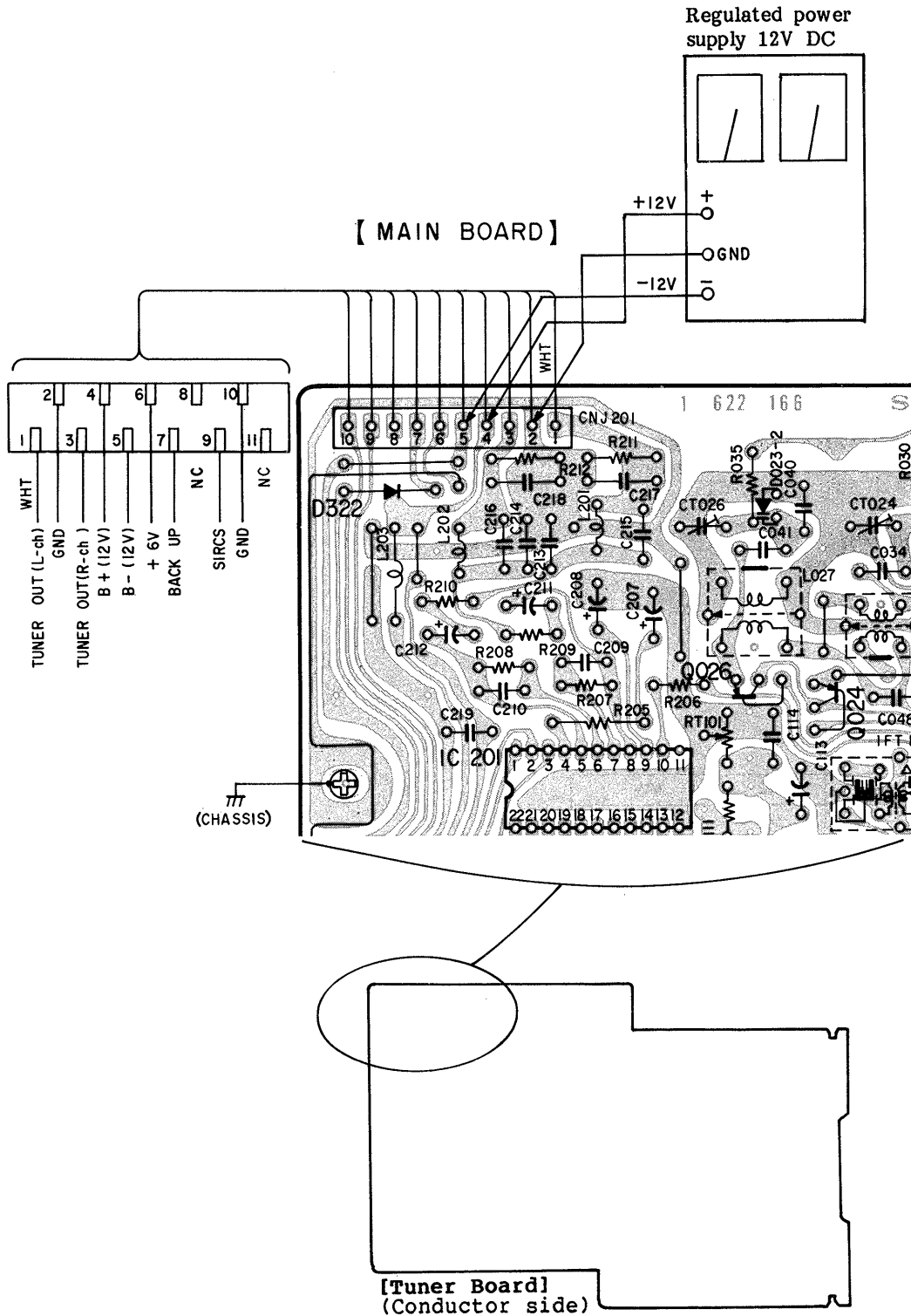

**Note on Ceramic Filter (CF101, 102) Replacement and Diode D314, 315 Connection.**

This set employs two ceramic filters (CF101, 102) which should have the same color marking to identify their center frequency. Therefore FM IF offset adjustment by diodes (D314, 315) connection is necessary to match the center frequency of the ceramic filters used with FM intermediate frequency.

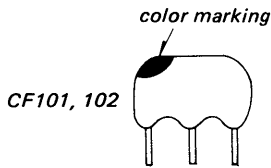

○: connect  
X: not connect

Ceramic filter		D314, 315 connection		FM intermediate frequency (MHz)
Color mark	Center frequency (MHz)	*A (D314)	*B (D315)	
White	10.750	○	X	10.750
Red	10.700	X	X	10.700
Black	10.650	X	○	10.650

FM intermediate frequency is determined by the three types as shown above. Ceramic filters of same center frequency, i.e., of same color coding should be used for CF101 and CF102.

When replacing the ceramic filters, perform the FM Discriminator Adjustment.

**MODEL IDENTIFICATION**

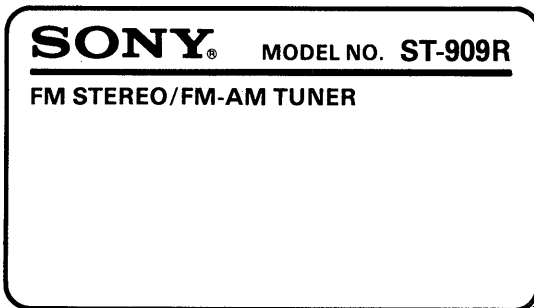

## PARTS IDENTIFICATION

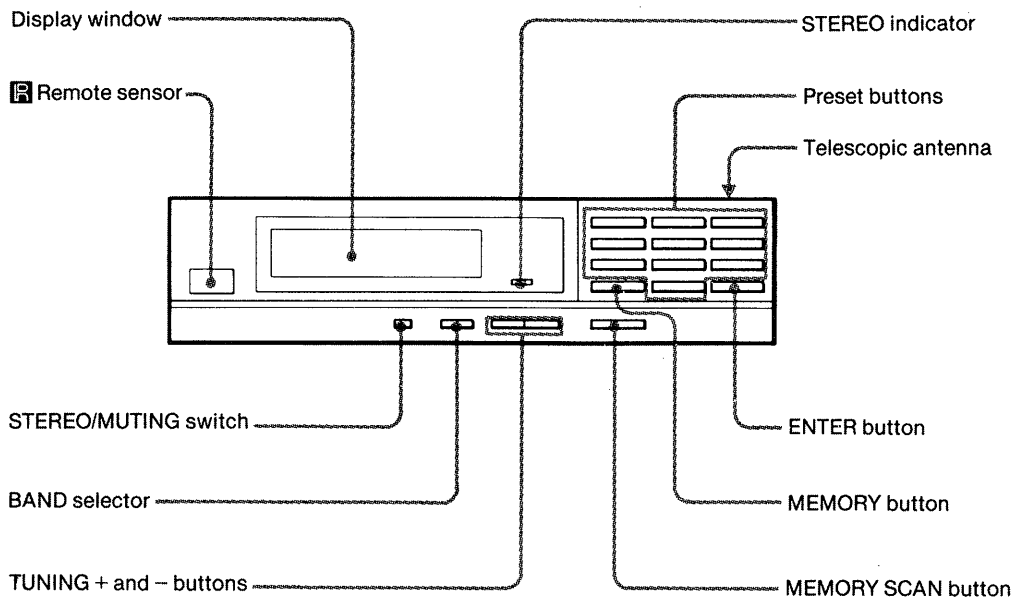

# SECTION 1

## ELECTRICAL ADJUSTMENTS

**FM SECTION**

**Setting:**

BAND selector switch: FM

**Note:** FM discriminator alignment should be made after FM tracking adjustment.

**FM Tracking Adjustment**

**Setting:**

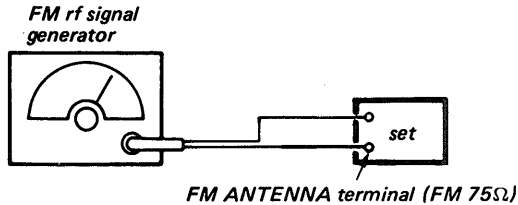

Carrier frequency: 98 MHz  
 Modulation: 1 kHz, 75 kHz deviation  
 Output level: 3.16μV (10 dB)

**Procedure:**

1. Push TUNING (+, -) button for 98 MHz.
2. Approach L002 and L003 not to touch each other.
3. Adjust L001 and L003, and repeat the adjustment 2 - 3 times for maximum VTVM reading.

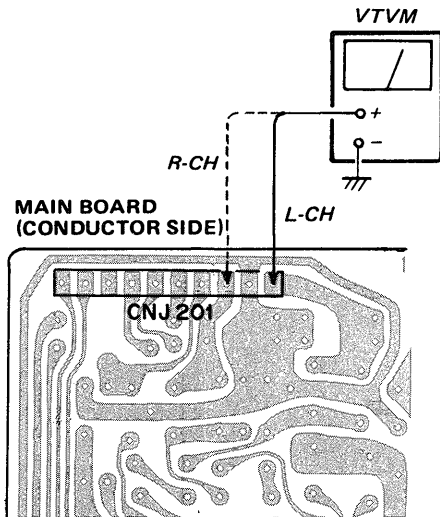

CNJ201

**FM Discriminator Alignment (NULL Check)**

**Setting:**

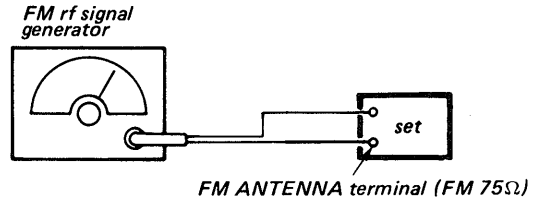

Carrier frequency: 98 MHz  
 Modulation: 1 kHz, 75 kHz deviation  
 Output level: 1 mV (60 dB)

VOM  
 (DC range)

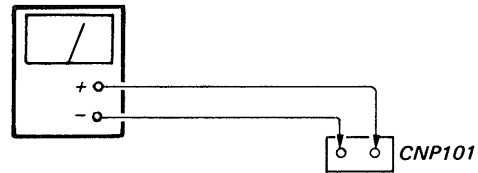

**Procedure:**

1. Push the TUNING (+, -) button for 98 MHz.
2. Adjust IFT101 for 0 V reading on the VOM.

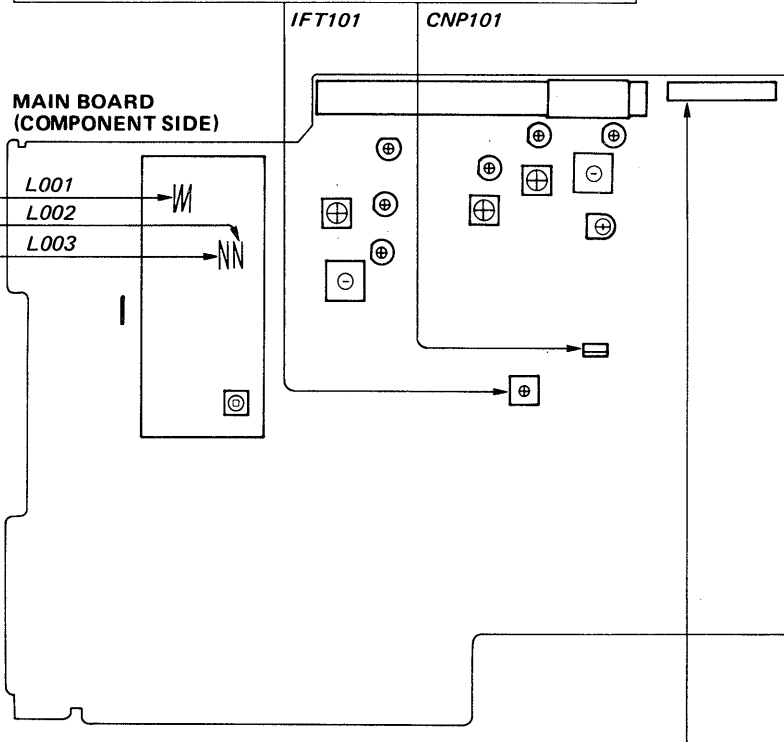

## FM OSC Voltage Adjustment

### Setting:

FM rf signal generator

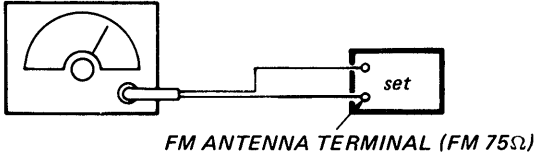

Carrier frequency: 108 MHz  
 Modulation: 1 kHz, 75 kHz deviation  
 Output level: as low as possible

### Procedure:

1. Push the TUNING (+, -) button for 108 MHz.
2. Adjust L005 for 8 – 8.5 V reading on the VOM.

VOM  
(DC range)

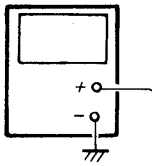

## FM TUNED Indication Lighting Level Adjustment

### Setting:

FM rf signal generator

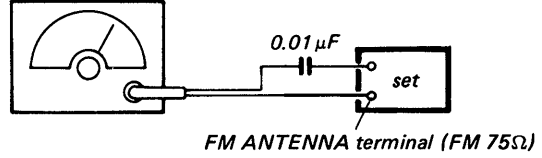

Carrier frequency: 98 MHz  
 Modulation: 1 kHz, 75 kHz deviation  
 Output level: 22.4 μV (27 dB)

### Procedure:

1. Confirm that the MUTING indicator lights up on the display window.
2. Tune the set to 98 MHz.
3. Adjust RT101 so that the TUNED indicator goes on.

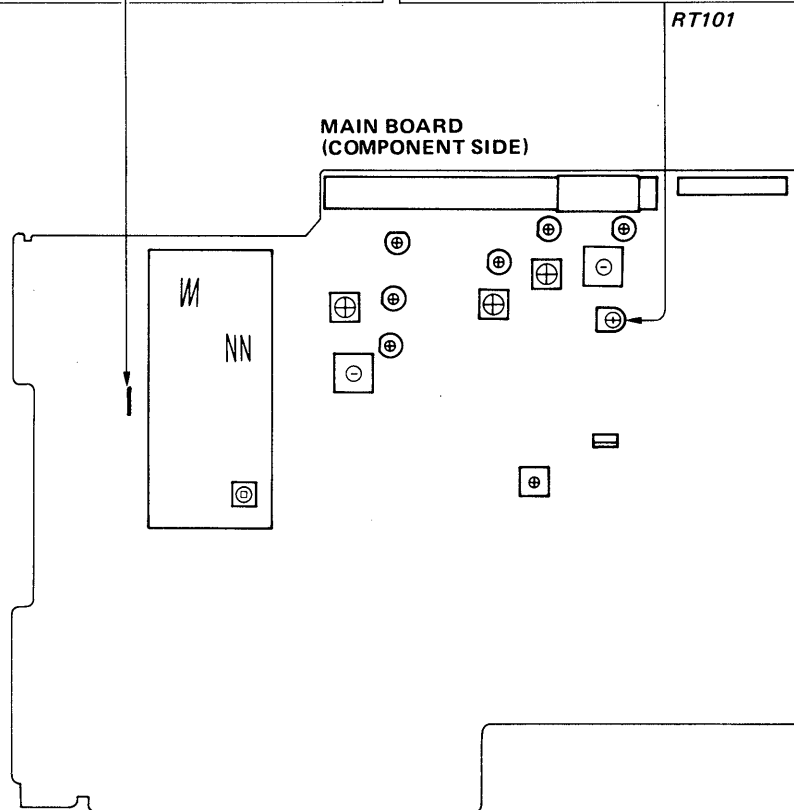

**MW SECTION**

**Setting:**

BAND selector switch: MW

AM rf signal generator

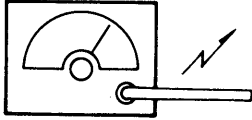

Put the lead-wire antenna close to the set.

30% amplitude modulation by 400 Hz signal

- Repeat the procedures in each adjustment several times, and the OSC voltage and tracking adjustments should be finally done by the trimmer capacitors.

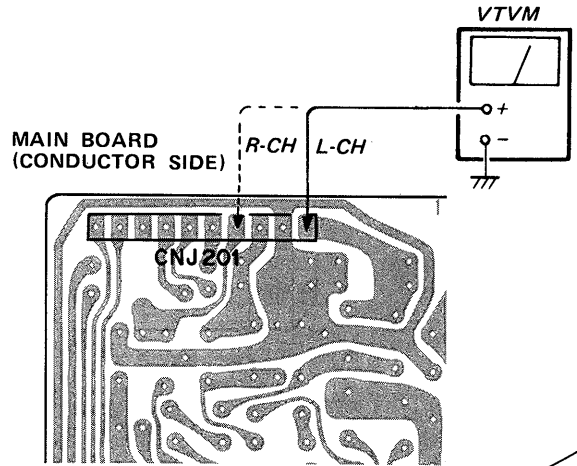

MW TRACKING ADJUSTMENT	
Adjust for a maximum reading on VTVM.	
600 kHz	L022
1,400 kHz	CT021

**MW OSC Voltage Adjustment**

**Procedure:**

1. Tune the set to 530 kHz by pressing TUNING (+, -) button.
2. Press the button for 1,611 kHz. Adjust CT022 for 8 - 8.5 V VOM reading.

VOM (DC range)

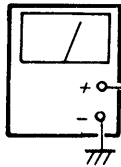

**MAIN BOARD (COMPONENT SIDE)**

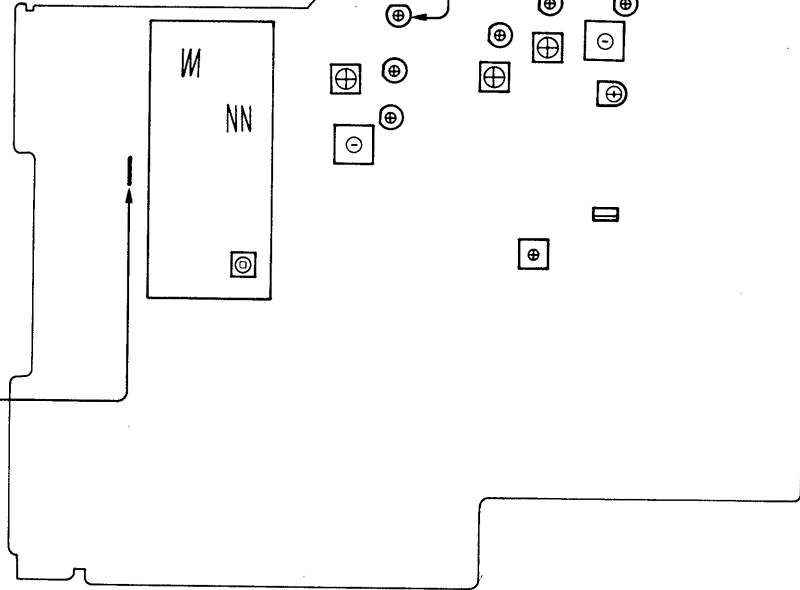

## SW SECTION

### Setting:

BAND selector switch: SW1 or 2

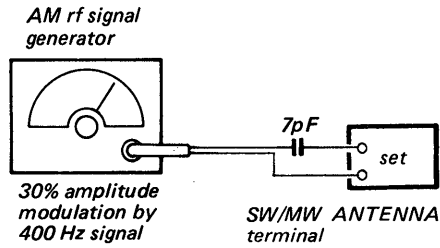

- Repeat the procedures in each adjustment several times, and the OSC voltage and tracking adjustments should be finally done by the trimmer capacitors.

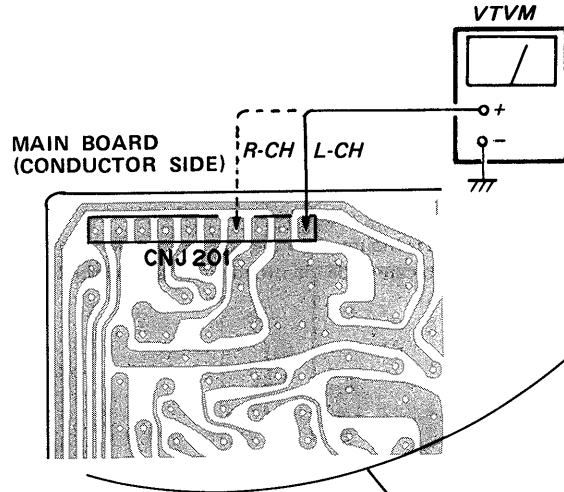

SW 1 TRACKING ADJUSTMENT	
Adjust for maximum reading on VTVM.	
7.3 MHz	CT023
3.2 MHz	L024

SW 2 TRACKING ADJUSTMENT	
Adjust for a maximum reading on VTVM.	
21.75 MHz	CT025
9.5 MHz	L026

### MAIN BOARD (COMPONENT SIDE)

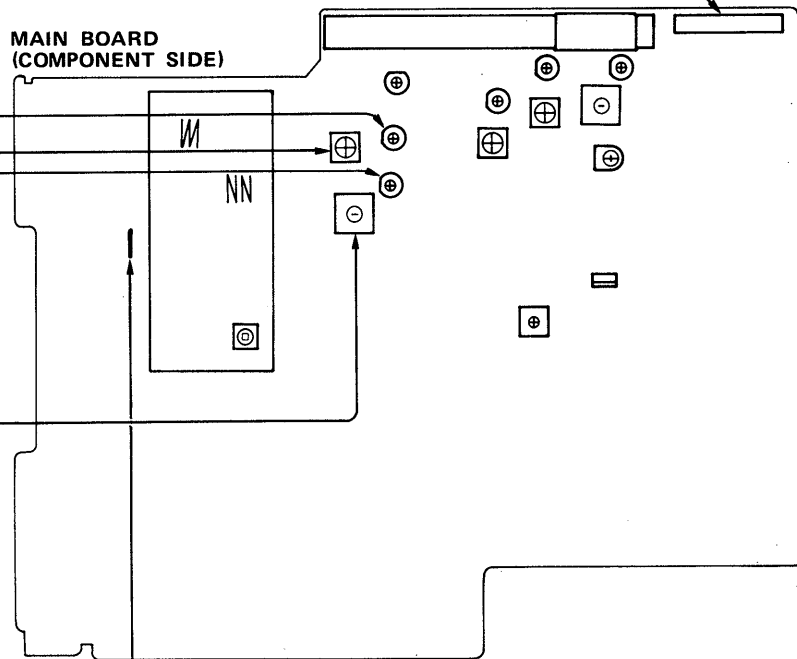

### SW 1/ SW 2 OSC Voltage Adjustment

#### Procedure:

- Set BAND selector switch to SW 1.
- Press TUNING (+, -) button for 3.2 MHz. Adjust L025 for 1 - 1.1 V VOM reading.
- Press the button for 7.3 MHz. Adjust CT024 for 8 - 8.5 V reading.
- Set BAND selector switch to SW 2.
- Press TUNING (+, -) button for 9.5 MHz. Adjust L027 for 1 - 1.1 V reading.
- Press the button for 21.75 MHz. Adjust CT026 for 8 - 8.5 V VOM reading.

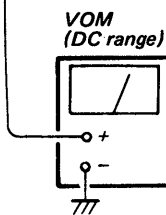





SECTION 2  
DIAGRAMS

2-1. PRINTED WIRING BOARDS

. See page 14 for Semiconductor Lead Layouts.

Note:

-  : parts mounted on the conductor side.
-  indicates side identified with part number.

. Semiconductor Location

Ref. No.	Location	Ref. No.	Location
IC101	D-5	D024	B-7
IC201	C-3	D026	C-7
IC301	F-6	D027	C-7
IC302	F-8	D028	C-6
IC402	F-3	D029	D-7
Q001	C-7	D030	C-6
Q002	D-8	D031	C-6
Q003	D-8	D101	D-5
Q004	E-8	D201	D-3
Q021	D-7	D202	H-1
Q022	C-5	D301	E-3
Q023	C-7	D302	F-5
Q024	C-4	D303	G-5
Q025	D-7	D304	E-4
Q026	C-4	D305	E-4
Q101	D-6	D306	E-4
Q201	D-3	D307	E-4
Q202	D-3	D308	E-5
Q301	E-3	D309	E-5
Q302	F-7	D310	E-5
Q303	F-7	D311	E-5
Q304	F-7	D312	E-5
Q305	F-7	D313	E-6
Q306	F-7	D314	E-6
Q307	F-8	D315	E-6
Q308	F-7	D316	E-6
Q309	F-9	D318	E-6
Q310	F-9	D319	F-2
Q401	E-2	D320	G-4
Q402	E-2	D321	G-4
D001	C-7	D322	B-2
D002	C-7	D401	H-9
D003	C-7	D402	E-3
D004	D-7	D403	E-3
D021-1	B-6	D404	F-2
D021-2	B-5		
D022-1	C-6		
D022-2	B-5		
D023-1	C-6		
D023-2	B-4		

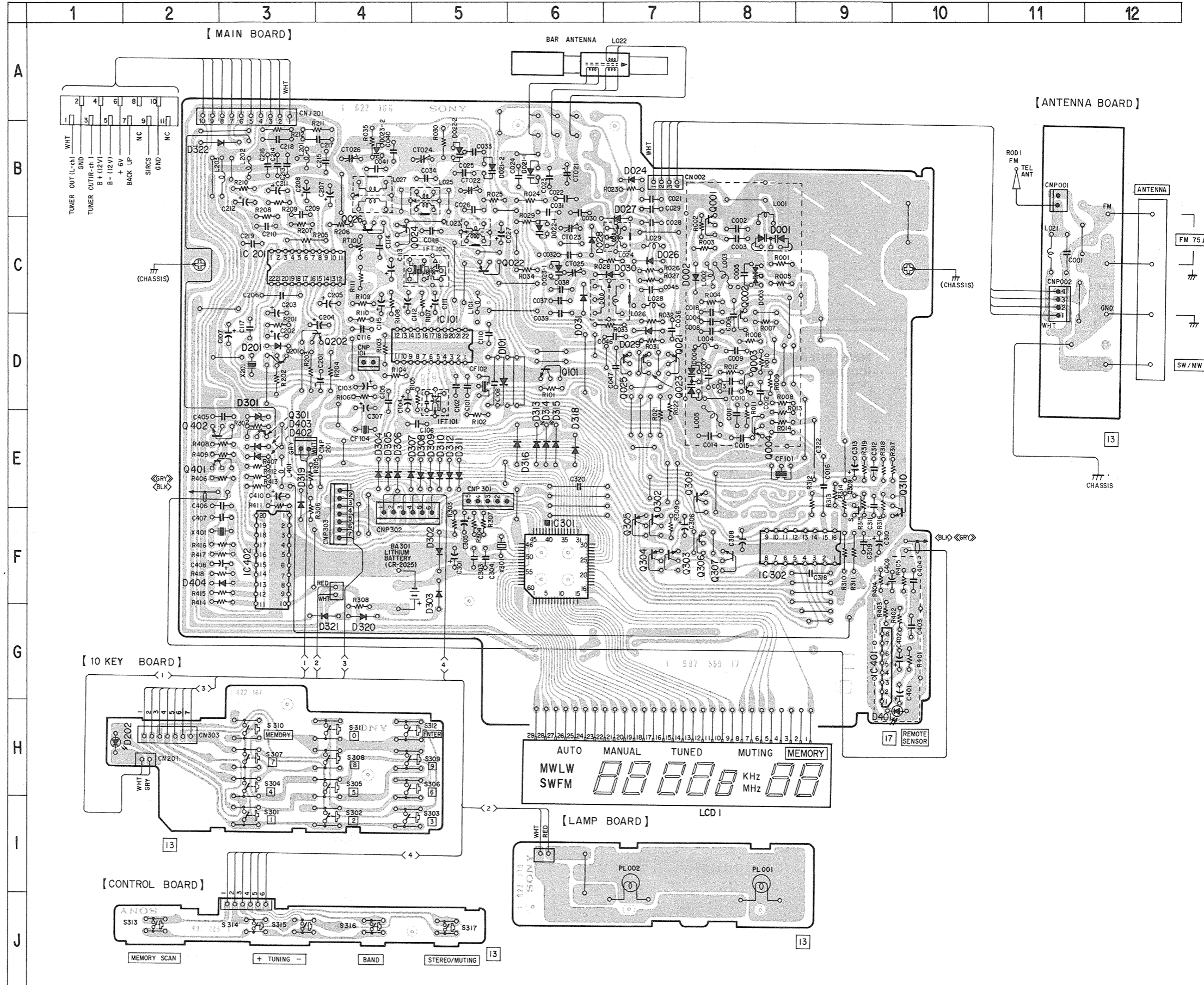

2-2. SCHEMATIC DIAGRAM . See page 13 for note.

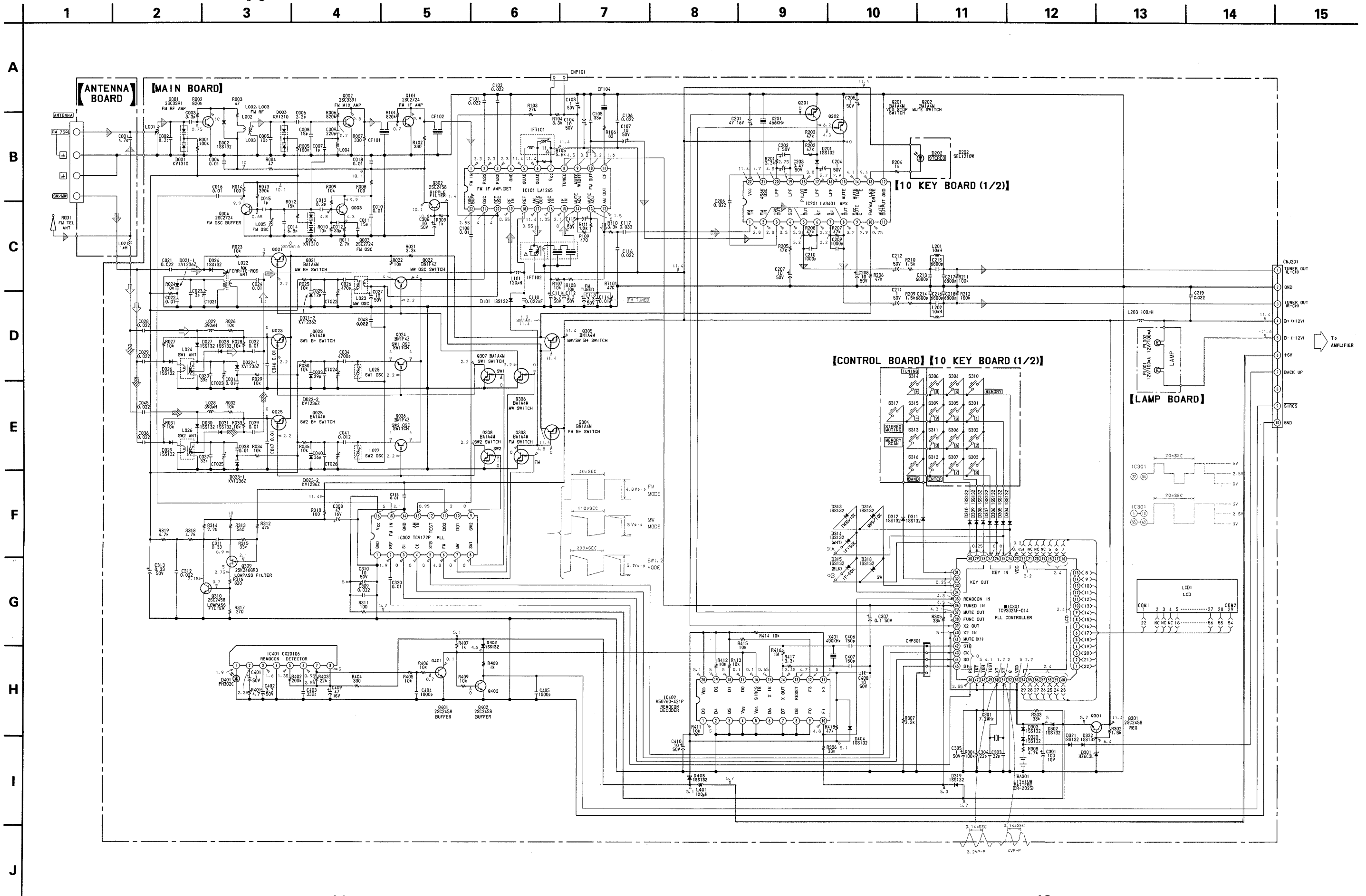

**Note:**

- All capacitors are in  $\mu\text{F}$  unless otherwise noted. pF:  $\mu\mu\text{F}$  50WV or less are not indicated except for electrolytics and tantalums.
- All resistors are in  $\Omega$  and  $\frac{1}{4}\text{W}$  or less unless otherwise specified.
- \*A·B: See page 3 "Note on ceramic filter replacement and diode connection".
- $\Delta$  : internal component.
- $\rightarrow$  : FM signal path.
- $\rightarrow$  : MW signal path.
- $\rightarrow$  : SW1 signal path.
- $\rightarrow$  : SW2 signal path.
- $\rightarrow$  : B+ bus.
- $\rightarrow$  : B- bus.
- $\square$  : adjustment for repair.
- Voltages are dc with respect to ground unless otherwise noted.
- Readings are taken under detuned conditions with a VOM (50k $\Omega$ /V).
- No Mark: FMI Mode
- Voltage variations may be noted due to normal production tolerances.
- Waveforms are taken to ground in no-signal mode by using oscilloscope.
- Voltage variations may be noted due to normal production tolerances.

● Switches:

Ref. No.	Switch	Position
S301	1	OFF
S302	2	OFF
S303	3	OFF
S304	4	OFF
S305	5	OFF
S306	6	OFF
S307	7	OFF
S308	8	OFF
S309	9	OFF
S310	MEMORY	OFF
S311	0	OFF
S312	ENTER	OFF
S313	MEMORY SCAN	OFF
S314	TUNING +	OFF
S315	TUNING -	OFF
S316	BAND	OFF
S317	STEREO MUTING	OFF

**IC101 LA1265**

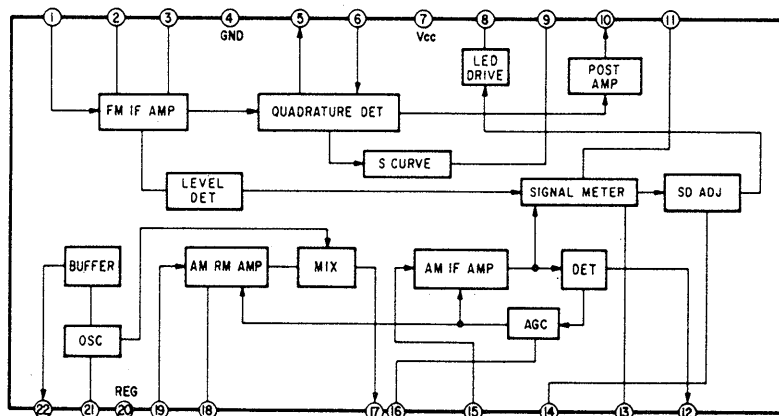

**IC201 LA3401**

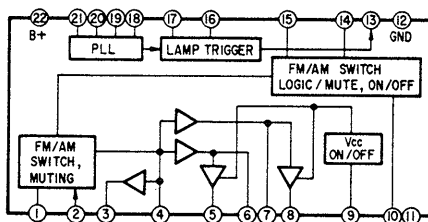

**IC302 TC9172P**

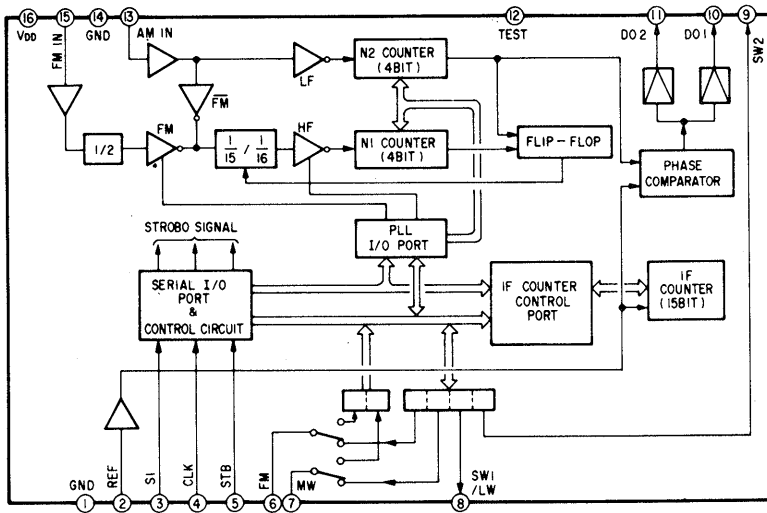

**IC401 CX20106A**

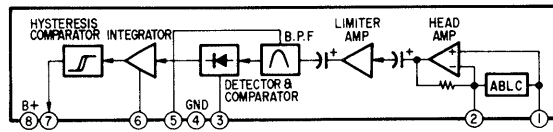

● **Semiconductor Lead Layouts**

<p><b>US1060M</b> <b>HZS6C3L</b></p> <p>cathode anode</p>	<p><b>KV1236Z</b></p> <p>anode 1 cathode 1 anode 2 cathode 2</p>	<p><b>LA1265</b> <b>LA3401</b></p> <p>(Top view)</p>	<p><b>2SC2724-C</b> <b>2SC2724-D</b> <b>2SC3391</b> <b>2SC634SP</b></p> <p>E C B</p>
<p><b>KV1310</b></p> <p>anode 1 cathode anode 2</p>	<p><b>SEL1210W</b></p> <p>long short anode cathode</p>	<p><b>CX20106A</b></p> <p>1 2 3 4 5 6 7 8</p>	<p><b>BN1A4M</b> <b>BN1F4Z</b></p> <p>factor wire C B</p>
<p><b>PH302C</b></p> <p>cathode anode</p>	<p><b>TC9172AP</b></p> <p>(Top view)</p>	<p><b>TC9302AF-014</b></p> <p>1 15 16 30 31 45 46</p>	
<p><b>M50760-421P</b></p> <p>(Top view)</p>	<p><b>2SK246-GR2</b></p> <p>S G D</p>		

## SECTION 3 EXPLODED VIEWS

**NOTE:**

- The mechanical parts with no reference number in the exploded views are not supplied.
- The construction parts of an assembled part are indicated with a collation number in the remark column.
- Items marked "★" are not stocked since they are seldom required for routine service. Some delay should be anticipated when ordering these items.

- Due to standardization, parts with part number suffix -XX and -X may be different from the parts specified in the components used on the set.

- Color Indication of Appearance Parts  
Example:  
(RED) ... KNOB, BALANCE (WHITE)  
↑ Cabinet's Color                      ↑ Parts Color

The components identified by mark or dotted line with mark are critical for safety. Replace only with part number specified.

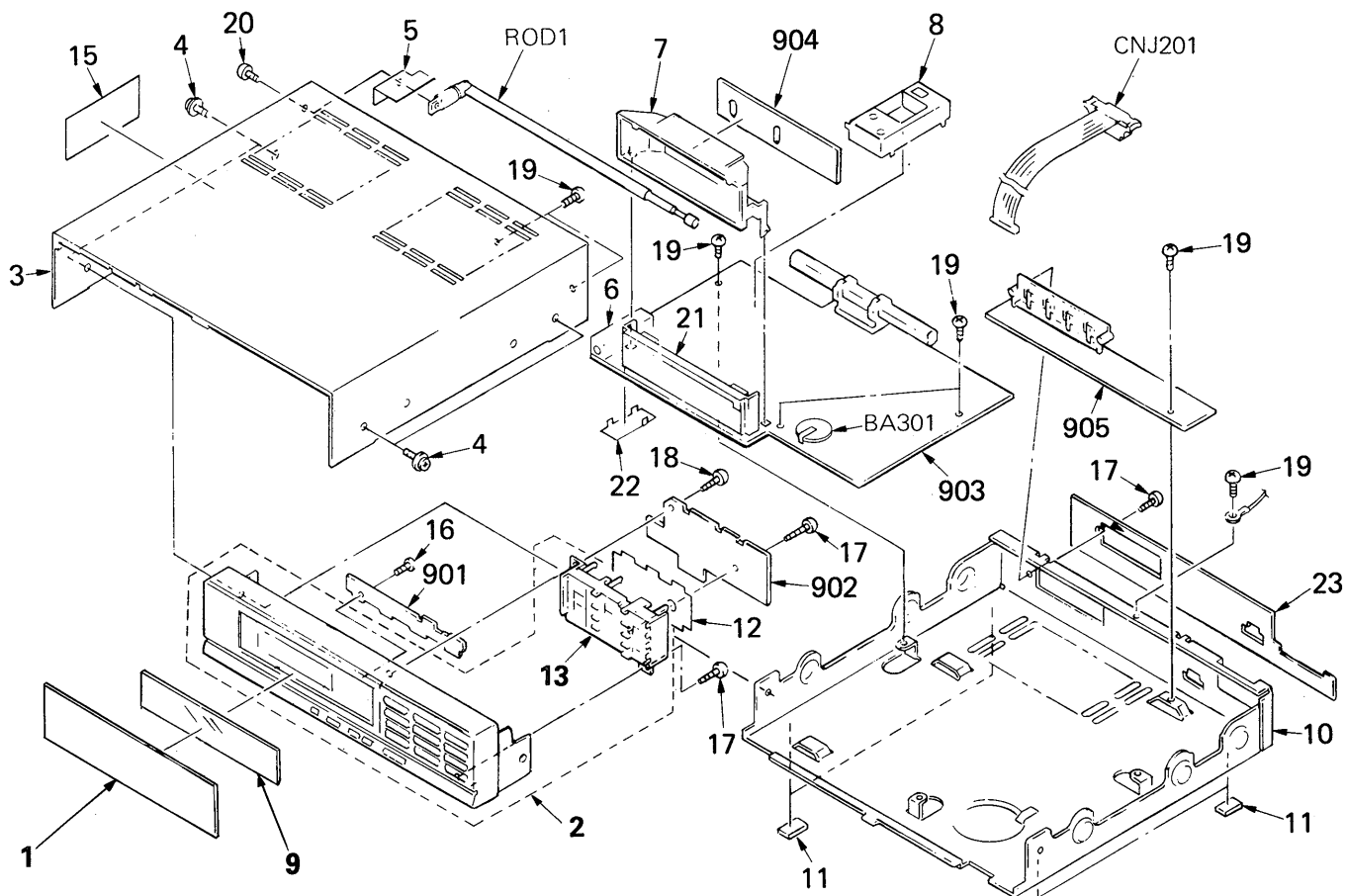

No.	Part No.	Description	Remarks	No.	Part No.	Description	Remarks
1	4-919-610-61	PLATE, ORNAMENTAL		17	7-685-647-79	SCREW +BVTP 3X10	TYPE2 N-S
2	X-4919-662-1	PANEL ASSY, FRONT	13	18	7-685-646-79	SCREW +BVTP 3X8	TYPE2 N-S
3	4-920-137-01	CASE		19	7-682-147-01	SCREW +BVIT 3X6	(S)
4	3-704-366-01	SCREW (CASE) (M3X8)		20	7-682-547-09	SCREW +B 3X6	
5	*4-919-611-01	BRACKET, ANT		21	*4-909-633-01	ILLUMINATOR	
6	*4-909-705-01	PLATE, SHIELD		22	*4-920-149-01	PLATE (A), SHIELD	
7	*4-917-275-01	HOUSE, LAMP		23	*4-919-613-31	COVER, REAR	
8	*4-874-704-01	CASE, SHIELD		901	*1-622-168-11	PC BOARD, CONTROL	
9	4-919-609-41	PLATE, INDICATION		902	*1-622-167-11	PC BOARD, 10 KEY	
10	*4-919-617-01	CHASSIS		903	*A-4351-630-A	MOUNTED PCB, TUNER	
11	4-919-608-01	FOOT		904	*1-622-170-11	PC BOARD, LAMP	
12	*4-919-607-01	SPACER		905	*1-622-169-11	PC BOARD, ANTENNA	
13	*4-919-614-01	RETAINER, BUTTON		BA301	1-528-120-00	BATTERY, LITHIUM (CR-2025)	
15	*4-922-711-01	LABEL, MODEL NUMBER (E2/E3)		CNJ201	1-559-816-11	CORD (WITH CONNECTOR) 10P	
16	7-685-133-19	SCREW +P 2.6X6 TYPE2 SLIT		ROD1	1-501-270-00	ANTENNA, TELESCOPIC	

## SECTION 4 ELECTRICAL PARTS LIST

**NOTE:**

- Due to standardization, replacements in the parts list may be different from the parts specified in the diagrams or the components used on the set.
- Items marked "\*" are not stocked since they are seldom required for routine service. Some delay should be anticipated when ordering these items.
- If there are two or more same circuits in a set such as a stereophonic machine, only typical circuit parts may be indicated and capacitors and resistors in other same circuits may be omitted.

**CAPACITORS:**  
MF:  $\mu$ F, PF:  $\mu$ F.

**RESISTORS**

- All resistors are in ohms.
- F: nonflammable

**COILS**

- MMH: mH, UH:  $\mu$ H

**SEMICONDUCTORS**

In each case, U:  $\mu$ , for example:

UA...:  $\mu$ A..., UPA...:  $\mu$ PA...,  
UPC...:  $\mu$ PC, UPD...:  $\mu$ PD...

The components identified by mark  $\Delta$  or dotted line with mark  $\Delta$  are critical for safety. Replace only with part number specified.

Ref.No.	Part No.	Description			
901	*1-622-168-11	PC BOARD, CONTROL			
902	*1-622-167-11	PC BOARD, 10 KEY			
903	*A-4351-630-A	MOUNTED PCB, TUNER			
904	*1-622-170-11	PC BOARD, LAMP			
905	*1-622-169-11	PC BOARD, ANTENNA			
BA301	1-528-120-00	BATTERY, LITHIUM (CR-2025)			
C001	1-162-195-31	CERAMIC	4.7PF	10%	50V
C002	1-162-198-31	CERAMIC	8.2PF	10%	50V
C003	1-162-193-31	CERAMIC	3.3PF	10%	50V
C004	1-161-379-00	CERAMIC	0.01MF	20%	16V
C005	1-162-199-31	CERAMIC	10PF	5%	50V
C006	1-162-191-31	CERAMIC	2.2PF	10%	50V
C007	1-162-187-31	CERAMIC	1PF	20%	50V
C008	1-162-203-31	CERAMIC	15PF	5%	50V
C009	1-162-286-31	CERAMIC	220PF	10%	50V
C010	1-161-379-00	CERAMIC	0.01MF	20%	16V
C011	1-162-203-31	CERAMIC	15PF	5%	50V
C012	1-162-211-31	CERAMIC	33PF	5%	50V
C013	1-162-198-31	CERAMIC	8.2PF	10%	50V
C014	1-162-197-31	CERAMIC	6.8PF	10%	50V
C015	1-162-187-31	CERAMIC	1PF	20%	50V
C016	1-161-379-00	CERAMIC	0.01MF	20%	16V
C018	1-161-379-00	CERAMIC	0.01MF	20%	16V
C021	1-101-005-00	CERAMIC	0.022MF		50V
C022	1-161-379-00	CERAMIC	0.01MF	20%	16V
C023	1-102-936-00	CERAMIC	3PF	0.25PF	50V
C024	1-161-379-00	CERAMIC	0.01MF	20%	16V
C025	1-102-949-00	CERAMIC	12PF	5%	50V
C026	1-130-014-00	FILM	470PF	5%	50V
C027	1-123-875-11	ELECT	10MF	20%	50V
C028	1-101-005-00	CERAMIC	0.022MF		50V
C029	1-101-005-00	CERAMIC	0.022MF		50V
C030	1-102-965-00	CERAMIC	39PF	5%	50V
C031	1-161-379-00	CERAMIC	0.01MF	20%	16V
C032	1-161-379-00	CERAMIC	0.01MF	20%	16V
C033	1-102-965-00	CERAMIC	39PF	5%	50V
C034	1-130-479-00	MYLAR	0.0047MF	5%	50V
C036	1-101-005-00	CERAMIC	0.022MF		50V
C037	1-102-963-00	CERAMIC	33PF	5%	50V
C038	1-161-379-00	CERAMIC	0.01MF	20%	16V
C039	1-161-379-00	CERAMIC	0.01MF	20%	16V
C040	1-102-964-00	CERAMIC	36PF	5%	50V
C041	1-130-484-00	MYLAR	0.012MF	5%	50V
C045	1-101-005-00	CERAMIC	0.022MF		50V
C046	1-161-379-00	CERAMIC	0.01MF	20%	16V

Ref.No.	Part No.	Description			
C047	1-161-379-00	CERAMIC	0.01MF	20%	16V
C048	1-101-005-00	CERAMIC	0.022MF		50V
C101	1-101-005-00	CERAMIC	0.022MF		50V
C102	1-101-005-00	CERAMIC	0.022MF		50V
C103	1-124-499-11	ELECT	1MF	20%	50V
C104	1-123-875-11	ELECT	10MF	20%	50V
C105	1-162-211-31	CERAMIC	33PF	5%	50V
C106	1-101-005-00	CERAMIC	0.022MF		50V
C107	1-123-875-11	ELECT	10MF	20%	50V
C108	1-161-379-00	CERAMIC	0.01MF	20%	16V
C110	1-101-005-00	CERAMIC	0.022MF		50V
C111	1-124-927-11	ELECT	4.7MF	20%	50V
C112	1-123-382-00	ELECT	3.3MF	20%	50V
C113	1-123-382-00	ELECT	3.3MF	20%	50V
C114	1-161-379-00	CERAMIC	0.01MF	20%	16V
C115	1-123-382-00	ELECT	3.3MF	20%	50V
C116	1-101-005-00	CERAMIC	0.022MF		50V
C117	1-130-489-00	MYLAR	0.033MF	5%	50V
C201	1-124-477-11	ELECT	47MF	20%	16V
C202	1-124-499-11	ELECT	1MF	20%	50V
C203	1-124-902-00	ELECT	0.47MF	20%	50V
C204	1-124-499-11	ELECT	1MF	20%	50V
C205	1-124-499-11	ELECT	1MF	20%	50V
C206	1-161-494-00	CERAMIC	0.022MF	30%	25V
C207	1-123-875-11	ELECT	10MF	20%	50V
C208	1-123-875-11	ELECT	10MF	20%	50V
C209	1-102-074-00	CERAMIC	0.001MF	10%	50V
C210	1-102-074-00	CERAMIC	0.001MF	10%	50V
C211	1-124-499-11	ELECT	1MF	20%	50V
C212	1-124-499-11	ELECT	1MF	20%	50V
C213	1-161-329-00	CERAMIC	0.0068MF	20%	16V
C214	1-161-329-00	CERAMIC	0.0068MF	20%	16V
C215	1-161-329-00	CERAMIC	0.0068MF	20%	16V
C216	1-161-329-00	CERAMIC	0.0068MF	20%	16V
C217	1-161-329-00	CERAMIC	0.0068MF	20%	16V
C218	1-161-329-00	CERAMIC	0.0068MF	20%	16V
C219	1-101-005-00	CERAMIC	0.022MF		50V
C301	1-124-443-00	ELECT	100MF	20%	10V
C303	1-102-959-00	CERAMIC	22PF	5%	50V
C304	1-102-959-00	CERAMIC	22PF	5%	50V
C305	1-124-499-11	ELECT	1MF	20%	50V
C306	1-123-875-11	ELECT	10MF	20%	50V
C307	1-124-463-00	ELECT	0.1MF	20%	50V
C308	1-124-477-11	ELECT	47MF	20%	16V
C309	1-101-005-00	CERAMIC	0.022MF		50V

Ref.No.	Part No.	Description				Ref.No.	Part No.	Description
C310	1-123-875-11	ELECT	10MF	20%	50V	D030	8-719-000-26	DIODE US1060M
C311	1-136-171-00	FILM	0.33MF	5%	50V	D031	8-719-000-26	DIODE US1060M
C312	1-130-487-00	MYLAR	0.022MF	5%	50V	D101	8-719-000-26	DIODE US1060M
C313	1-124-252-00	ELECT	0.33MF	20%	50V	D201	8-719-000-26	DIODE US1060M
C318	1-161-379-00	CERAMIC	0.01MF	20%	16V	D202	8-719-303-13	DIODE SEL1210W
C320	1-161-379-00	CERAMIC	0.01MF	20%	16V	D301	8-719-933-41	DIODE HZS6C3L
C401	1-124-499-11	ELECT	1MF	20%	50V	D302	8-719-000-26	DIODE US1060M
C402	1-123-382-00	ELECT	3.3MF	20%	50V	D303	8-719-000-26	DIODE US1060M
C403	1-162-288-31	CERAMIC	330PF	10%	50V	D304	8-719-000-26	DIODE US1060M
C404	1-162-294-31	CERAMIC	0.001MF	10%	50V	D305	8-719-000-26	DIODE US1060M
C405	1-162-294-31	CERAMIC	0.001MF	10%	50V	D306	8-719-000-26	DIODE US1060M
C406	1-101-361-00	CERAMIC	150PF	5%	50V	D307	8-719-000-26	DIODE US1060M
C407	1-101-361-00	CERAMIC	150PF	5%	50V	D308	8-719-000-26	DIODE US1060M
C408	1-123-875-11	ELECT	10MF	20%	50V	D309	8-719-000-26	DIODE US1060M
C409	1-124-477-11	ELECT	47MF	20%	16V	D310	8-719-000-26	DIODE US1060M
C410	1-123-875-11	ELECT	10MF	20%	50V	D311	8-719-000-26	DIODE US1060M
CF101	1-567-389-11	FILTER, CERAMIC				D312	8-719-000-26	DIODE US1060M
CF102	1-567-389-11	FILTER, CERAMIC				D313	8-719-000-26	DIODE US1060M
CF104	1-527-981-00	FILTER, CERAMIC				D314	8-719-000-26	DIODE US1060M
CNJ201	1-559-816-11	CORD (WITH CONNECTOR)				D315	8-719-000-26	DIODE US1060M
CNP001*1-560-060-00	PIN, CONNECTOR 2P					D316	8-719-000-26	DIODE US1060M
CNP002*1-564-338-00	PIN, CONNECTOR 4P					D318	8-719-000-26	DIODE US1060M
CNP101*1-560-060-00	PIN, CONNECTOR 2P					D319	8-719-000-26	DIODE US1060M
CNP201*1-564-336-00	PIN, CONNECTOR 2P					D320	8-719-000-26	DIODE US1060M
CNP301*1-560-063-00	PIN, CONNECTOR 5P					D321	8-719-000-26	DIODE US1060M
CNP302*1-560-064-00	PIN, CONNECTOR 6P					D322	8-719-000-26	DIODE US1060M
CNP303*1-564-341-11	PIN, CONNECTOR 7P					D401	8-719-123-68	PH302C
CT021	1-141-227-00	CAP, CERAMIC TRIMMER				D402	8-719-000-26	DIODE US1060M
CT022	1-141-227-00	CAP, CERAMIC TRIMMER				D403	8-719-000-26	DIODE US1060M
CT023	1-141-227-00	CAP, CERAMIC TRIMMER				D404	8-719-000-26	DIODE US1060M
CT024	1-141-227-00	CAP, CERAMIC TRIMMER				IC101	8-759-801-81	IC LA1265
CT025	1-141-227-00	CAP, CERAMIC TRIMMER				IC201	8-759-801-80	IC LA3401
CT026	1-141-227-00	CAP, CERAMIC TRIMMER				IC301	8-759-206-74	IC TC9302AF-014
D001	8-719-918-45	DIODE KV1310				IC302	8-759-230-16	IC TC9172AP
D002	8-719-000-26	DIODE US1060M				IC401	8-759-602-54	IC CX20106A
D003	8-719-918-45	DIODE KV1310				IC402	8-759-603-43	IC M50760-421P
D004	8-719-918-45	DIODE KV1310				IFT101	1-404-659-11	COIL, DISCRIMINATOR
D021	8-719-902-79	DIODE KV1236Z				IFT102	1-404-713-11	TRANSFORMER, IF
D022	8-719-902-79	DIODE KV1236Z				L001	*1-422-336-11	COIL, AIR-CORE
D023	8-719-902-79	DIODE KV1236Z				L002	*1-422-040-00	COIL, AIR-CORE
D024	8-719-000-26	DIODE US1060M				L003	*1-422-081-00	COIL (WITH CORE)
D026	8-719-000-26	DIODE US1060M				L004	*1-422-039-00	COIL, AIR-CORE
D027	8-719-000-26	DIODE US1060M				L005	1-459-396-00	COIL (WITH CORE)
D028	8-719-000-26	DIODE US1060M				L021	1-410-577-21	INDUCTOR 1UH
D029	8-719-000-26	DIODE US1060M						

Ref.No.	Part No.	Description
L022	1-402-152-11	ANTENNA, FERRITE-ROD (MW)
L023	1-406-089-11	COIL (OSC)
L024	1-402-145-11	COIL (ANT)
L025	1-406-205-11	COIL, SW1
L026	1-402-072-11	COIL (ANT) SW2
L027	1-406-106-11	COIL (OSC) SW2
L028	1-410-608-21	INDUCTOR 390UH
L029	1-410-608-21	INDUCTOR 390UH
L101	1-410-602-21	INDUCTOR 120UH
L201	1-408-924-00	INDUCTOR 10MMH
L202	1-408-924-00	INDUCTOR 10MMH
L203	1-410-601-21	INDUCTOR 100UH
L401	1-410-601-21	INDUCTOR 100UH
LCD1	1-807-453-41	DISPLAY PANEL, LIQUID CRYSTAL
PL001	1-518-527-51	LAMP, PILOT
PL002	1-518-527-51	LAMP, PILOT
Q001	8-729-304-38	TRANSISTOR 2SC3391
Q002	8-729-304-38	TRANSISTOR 2SC3391
Q003	8-729-672-42	TRANSISTOR 2SC2724C
Q004	8-729-672-42	TRANSISTOR 2SC2724C
Q021	8-729-115-15	TRANSISTOR BN1A4M
Q022	8-729-115-33	TRANSISTOR BN1F4Z
Q023	8-729-115-15	TRANSISTOR BN1A4M
Q024	8-729-115-33	TRANSISTOR BN1F4Z
Q025	8-729-115-15	TRANSISTOR BN1A4M
Q026	8-729-115-33	TRANSISTOR BN1F4Z
Q101	8-729-672-43	TRANSISTOR 2SC2724D
Q201	8-729-115-79	TRANSISTOR BA1A4M
Q202	8-729-115-79	TRANSISTOR BA1A4M
Q301	8-729-600-27	TRANSISTOR 2SC634SP
Q302	8-729-600-27	TRANSISTOR 2SC634SP
Q303	8-729-115-79	TRANSISTOR BA1A4M
Q304	8-729-115-15	TRANSISTOR BN1A4M
Q305	8-729-115-15	TRANSISTOR BN1A4M
Q306	8-729-115-79	TRANSISTOR BA1A4M
Q307	8-729-115-79	TRANSISTOR BA1A4M
Q308	8-729-115-79	TRANSISTOR BA1A4M
Q309	8-729-201-56	TRANSISTOR 2SK246GR2
Q310	8-729-600-27	TRANSISTOR 2SC634SP
Q401	8-729-600-27	TRANSISTOR 2SC634SP
Q402	8-729-600-27	TRANSISTOR 2SC634SP
R001	1-249-441-11	CARBON 100K 5% 1/4W
R002	1-215-491-00	CARBON 820K 5% 1/4W
R003	1-249-401-11	CARBON 47 5% 1/4W

Ref.No.	Part No.	Description
R004	1-249-401-11	CARBON 47 5% 1/4W
R005	1-249-441-11	CARBON 100K 5% 1/4W
R006	1-215-491-00	CARBON 820K 5% 1/4W
R007	1-249-411-11	CARBON 330 5% 1/4W
R008	1-249-405-11	CARBON 100 5% 1/4W
R009	1-249-429-11	CARBON 10K 5% 1/4W
R010	1-249-429-11	CARBON 10K 5% 1/4W
R011	1-249-422-11	CARBON 2.7K 5% 1/4W
R012	1-249-431-11	CARBON 15K 5% 1/4W
R013	1-215-483-00	CARBON 390K 5% 1/4W
R014	1-249-405-11	CARBON 100 5% 1/4W
R021	1-249-423-11	CARBON 3.3K 5% 1/4W
R022	1-249-429-11	CARBON 10K 5% 1/4W
R023	1-249-429-11	CARBON 10K 5% 1/4W
R024	1-249-429-11	CARBON 10K 5% 1/4W
R025	1-249-429-11	CARBON 10K 5% 1/4W
R026	1-249-429-11	CARBON 10K 5% 1/4W
R027	1-249-429-11	CARBON 10K 5% 1/4W
R028	1-249-429-11	CARBON 10K 5% 1/4W
R029	1-249-429-11	CARBON 10K 5% 1/4W
R030	1-249-429-11	CARBON 10K 5% 1/4W
R031	1-249-429-11	CARBON 10K 5% 1/4W
R032	1-249-429-11	CARBON 10K 5% 1/4W
R033	1-249-429-11	CARBON 10K 5% 1/4W
R034	1-249-429-11	CARBON 10K 5% 1/4W
R035	1-249-429-11	CARBON 10K 5% 1/4W
R101	1-215-491-00	CARBON 820K 5% 1/4W
R102	1-249-411-11	CARBON 330 5% 1/4W
R103	1-249-434-11	CARBON 27K 5% 1/4W
R104	1-249-423-11	CARBON 3.3K 5% 1/4W
R105	1-249-426-11	CARBON 5.6K 5% 1/4W
R106	1-249-404-00	CARBON 82 5% 1/4W
R107	1-249-429-11	CARBON 10K 5% 1/4W
R108	1-249-429-11	CARBON 10K 5% 1/4W
R109	1-249-413-11	CARBON 470 5% 1/4W
R110	1-249-423-11	CARBON 3.3K 5% 1/4W
R111	1-249-420-11	CARBON 1.8K 5% 1/4W
R201	1-249-423-11	CARBON 3.3K 5% 1/4W
R202	1-249-437-11	CARBON 47K 5% 1/4W
R203	1-249-437-11	CARBON 47K 5% 1/4W
R204	1-249-417-11	CARBON 1K 5% 1/4W
R205	1-249-437-11	CARBON 47K 5% 1/4W
R206	1-249-437-11	CARBON 47K 5% 1/4W
R207	1-249-437-11	CARBON 47K 5% 1/4W
R208	1-249-437-11	CARBON 47K 5% 1/4W



Ref.No.	Part No.	Description					Ref.No.	Part No.	Description
R209	1-249-419-11	CARBON	1.5K	5%	1/4W		S301	1-554-303-21	SWITCH, KEY BOARD
R210	1-249-419-11	CARBON	1.5K	5%	1/4W		S302	1-554-303-21	SWITCH, KEY BOARD
R211	1-249-441-11	CARBON	100K	5%	1/4W		S303	1-554-303-21	SWITCH, KEY BOARD
R212	1-249-441-11	CARBON	100K	5%	1/4W		S304	1-554-303-21	SWITCH, KEY BOARD
R302	1-249-419-11	CARBON	1.5K	5%	1/4W		S305	1-554-303-21	SWITCH, KEY BOARD
R303	1-249-435-11	CARBON	33K	5%	1/4W		S306	1-554-303-21	SWITCH, KEY BOARD
R304	1-249-441-11	CARBON	100K	5%	1/4W		S307	1-554-303-21	SWITCH, KEY BOARD
R305	1-249-435-11	CARBON	33K	5%	1/4W		S308	1-554-303-21	SWITCH, KEY BOARD
R306	1-249-435-11	CARBON	33K	5%	1/4W		S309	1-554-303-21	SWITCH, KEY BOARD
R307	1-249-423-11	CARBON	3.3K	5%	1/4W		S310	1-554-303-21	SWITCH, KEY BOARD
R308	1-249-425-11	CARBON	4.7K	5%	1/4W		S311	1-554-303-21	SWITCH, KEY BOARD
R309	1-249-417-11	CARBON	1K	5%	1/4W		S312	1-554-303-21	SWITCH, KEY BOARD
R310	1-249-405-11	CARBON	100	5%	1/4W		S313	1-570-876-11	SWITCH, KEY BOARD
R311	1-249-405-11	CARBON	100	5%	1/4W		S314	1-570-876-11	SWITCH, KEY BOARD
R312	1-249-437-11	CARBON	47K	5%	1/4W		S315	1-570-876-11	SWITCH, KEY BOARD
R313	1-249-414-11	CARBON	560	5%	1/4W		S316	1-570-876-11	SWITCH, KEY BOARD
R314	1-249-421-11	CARBON	2.2K	5%	1/4W		S317	1-570-876-11	SWITCH, KEY BOARD
R315	1-249-435-11	CARBON	33K	5%	1/4W		TB001	1-536-708-00	TERMINAL BOARD, PUSH 4P
R316	1-249-416-11	CARBON	820	5%	1/4W		X201	1-567-250-11	OSCILLATOR, CERAMIC
R317	1-249-410-11	CARBON	270	5%	1/4W		X301	1-567-736-11	VIBRATOR, CRYSTAL
R318	1-249-425-11	CARBON	4.7K	5%	1/4W		X401	1-527-532-00	OSCILLATOR, CERAMIC
R319	1-249-425-11	CARBON	4.7K	5%	1/4W				
R401	1-249-389-11	CARBON	4.7	5%	1/4W				
R402	1-215-476-00	CARBON	200K	5%	1/4W				
R403	1-249-433-11	CARBON	22K	5%	1/4W				
R404	1-249-411-11	CARBON	330	5%	1/4W				
R405	1-249-429-11	CARBON	10K	5%	1/4W				
R406	1-249-429-11	CARBON	10K	5%	1/4W				
R407	1-249-417-11	CARBON	1K	5%	1/4W				
R408	1-249-417-11	CARBON	1K	5%	1/4W				
R409	1-249-429-11	CARBON	10K	5%	1/4W				
R411	1-249-429-11	CARBON	10K	5%	1/4W				
R412	1-249-429-11	CARBON	10K	5%	1/4W				
R413	1-249-429-11	CARBON	10K	5%	1/4W				
R414	1-249-429-11	CARBON	10K	5%	1/4W				
R415	1-249-429-11	CARBON	10K	5%	1/4W				
R416	1-215-493-00	CARBON	1M	5%	1/4W				
R417	1-249-423-11	CARBON	3.3K	5%	1/4W				
R418	1-249-437-11	CARBON	47K	5%	1/4W				
ROD1	1-501-270-00	ANTENNA, TELESCOPIC							
RT101	1-228-996-00	RES, ADJ, CARBON 47K							

